

Power supply

Generating 3.3V

USB-UART-Bridge

Input voltage measurement

Input current measurement

Supply operational amplifier

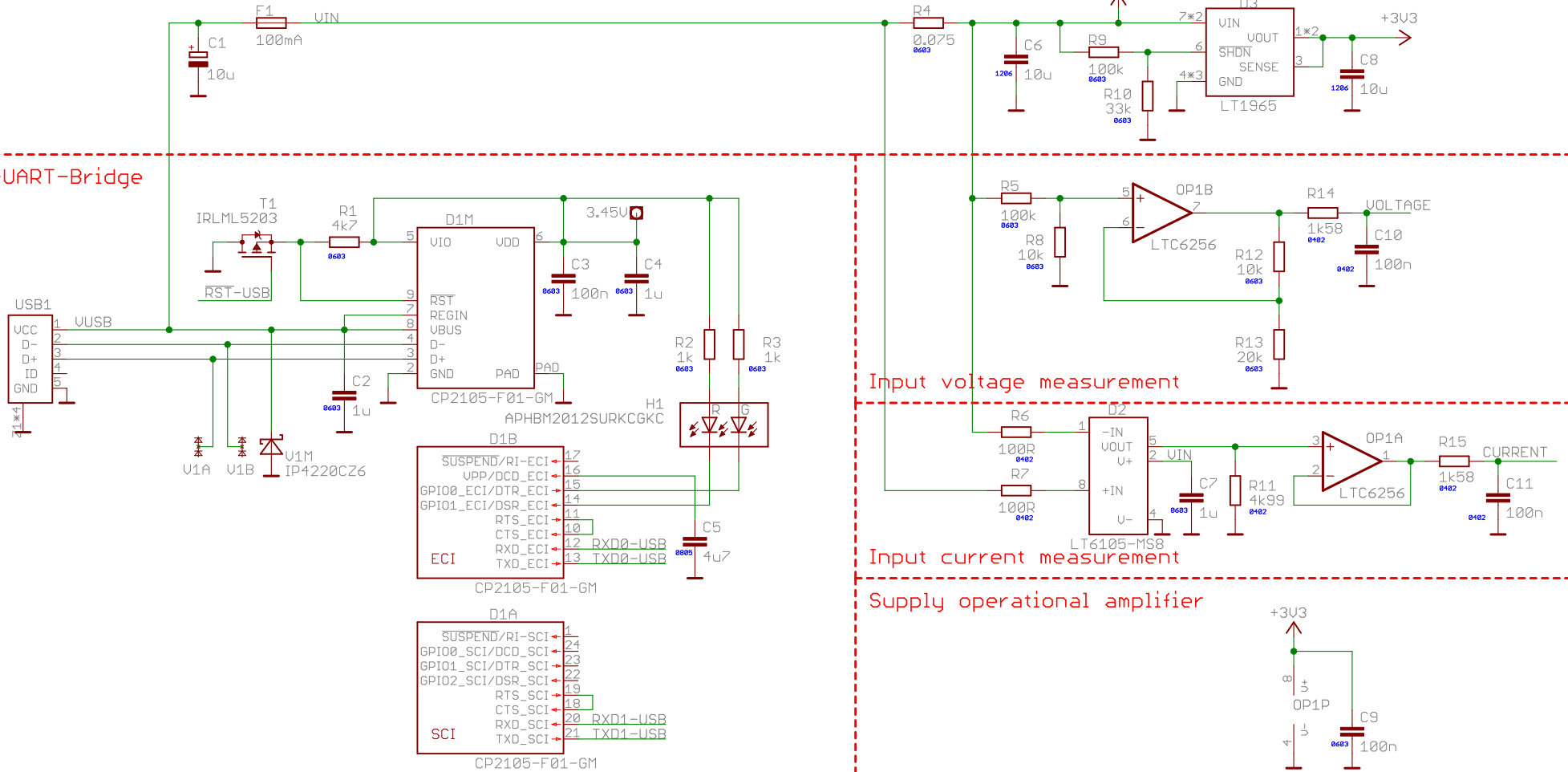

Author: M. Grünke	
TITLE: ADB-3a	
Document Number: 1.0	REV: 1.0
Date: 05.04.2020 18:00:16	Sheet: 1/3

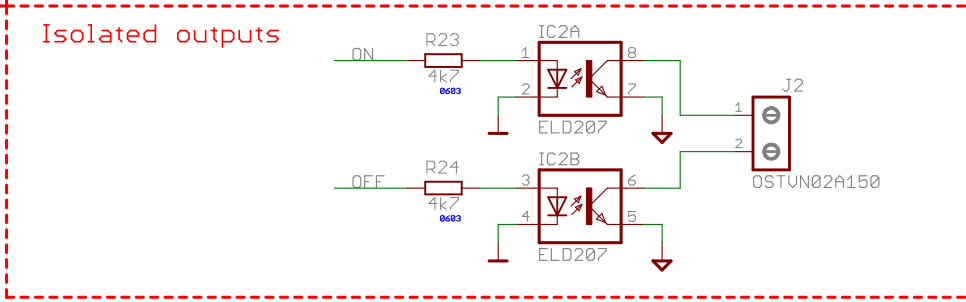
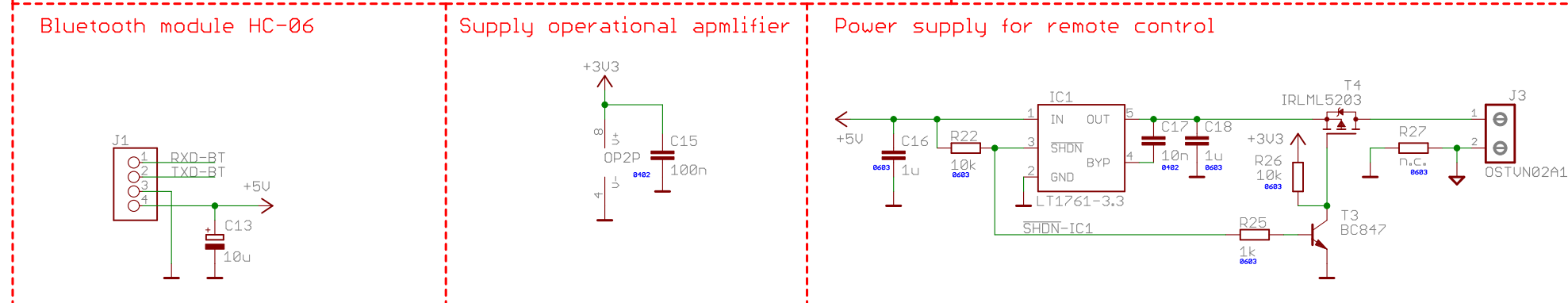
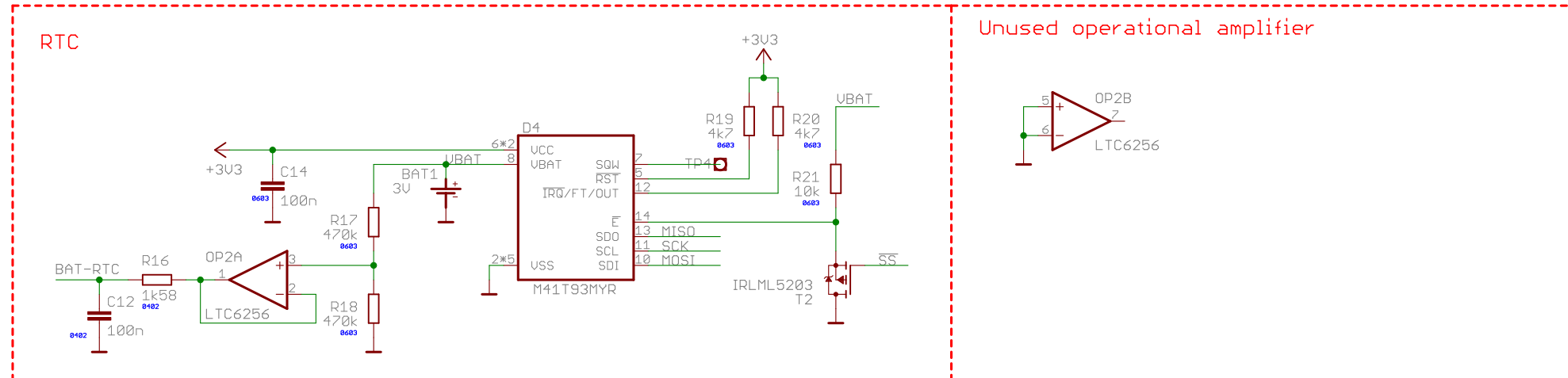

Author: M. Grünke	
TITLE: ADB-3a	
Document Number: 1.0	REV: 1.0
Date: 05.04.2020 18:00:16	Sheet: 2/3

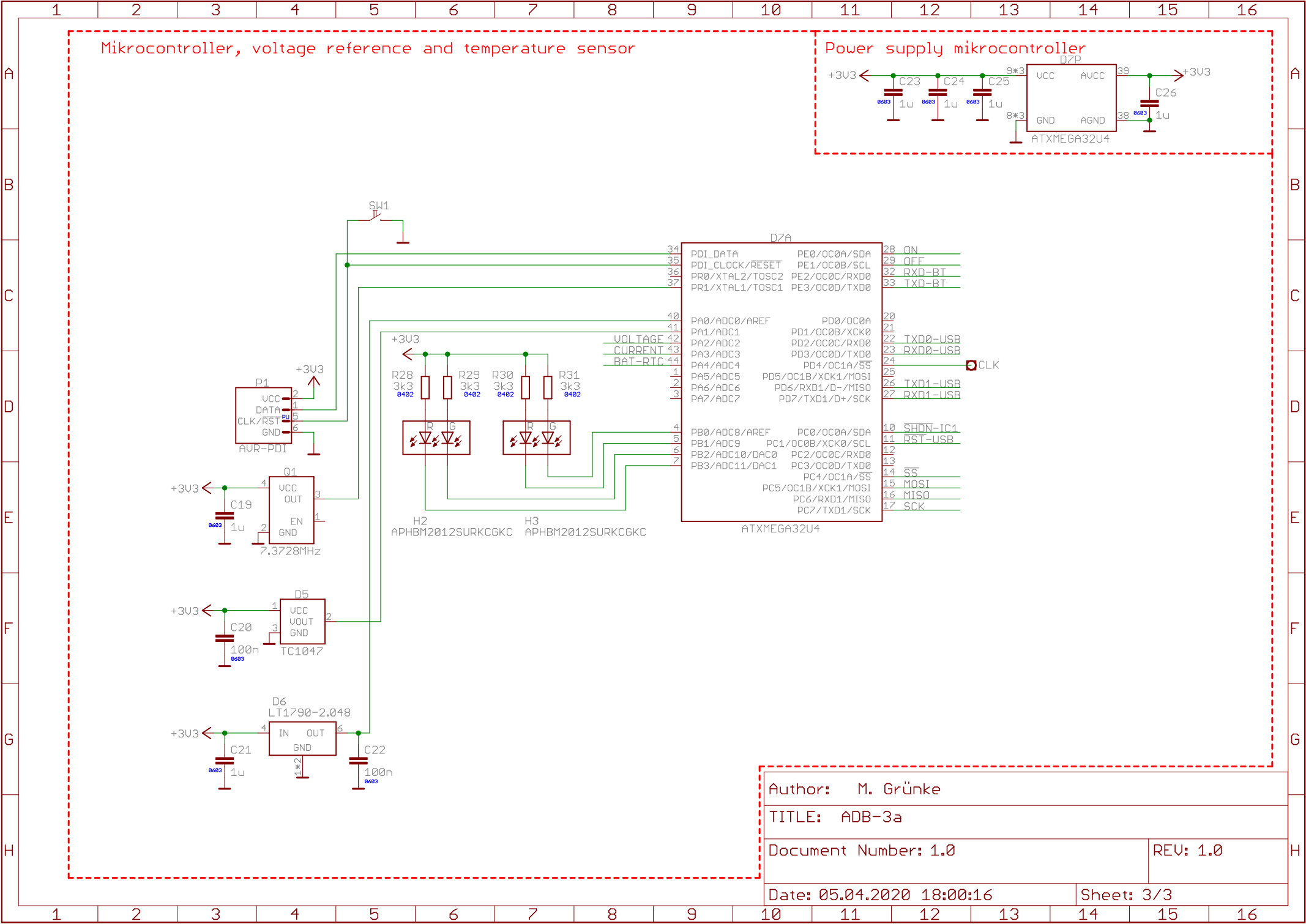

Author: M. Grünke

TITLE: ADB-3a

Document Number: 1.0

REV: 1.0

Date: 05.04.2020 18:00:16

Sheet: 3/3